

CAB[®]



HOOKS, HANGERS & MINE SAFETY PRODUCTS

Made by Cambria County Association for the Blind and Handicapped



Proudly Serving the Mining Industry for Over 35 Years

CAB® Cable Clips

In Round and Flat Wire Designs



Round Wire
CAB 314
CAB 315



100% Coated
Round Wire
CAB 929
CAB 936

CAB Round Wire Cable Clips

Strong, versatile hangers for supporting pipe or cables from messenger wire, plates, wire mesh or other structure. Made from .156 (4mm) high carbon spring steel wire with 5/8" (16mm) diameter top loops. CAB 961 is an extra long style for running multiple cables.

CAB 314 3-5/8" (92mm) dia., 6-1/2" (165mm) long, 100/box, 13 lbs. (5.9kg)

CAB 315 4-1/2" (114mm) dia., 7-3/8" (187mm) long, 50/box, 11 lbs. (5kg)

CAB 961 6" (152mm) dia., 11" (279mm) long, 50/box, 13 lbs. (5.9kg)



Round Wire
CAB 961

CAB 100% Plastisol Coated Round Wire Cable Clips

Manufactured as other round wire cable clips but coated over the entire surface with CAB plastisol for total insulation and corrosion resistance. 7/16" (11mm) diameter top loops.

CAB 929 3-5/8" (92mm) dia., 6-5/8" (168mm) long, 100/box, 16 lbs. (7.3kg)

CAB 936 4-1/2" (114mm) dia., 7-1/2" (191mm) long, 50/box, 12 lbs. (5.5kg)

CAB Flat Wire Cable Clips

Provide a safe, insulated 1/2" (13mm) wide surface carrying area for all types of cables. Easy to squeeze and latch for quick installation. Top loops receive special machine forming for additional weight carrying capacity. Corners are rounded for added safety. Made from 1/16" x 3/8" (2mm x 10mm) flat spring steel. 7/16" (11mm) diameter top loops.

CAB 300 2" (51mm) dia., 3-7/8" (98mm) long, 100/box, 13 lbs. (5.9kg)

CAB 299 2-5/8" (67mm) dia., 4-5/8" (117mm) long, 100/box, 15 lbs. (6.8kg)

CAB 298 3-7/8" (98mm) dia., 6-3/4" (171mm) long, 50/box, 9 lbs. (4.1kg)

CAB 940 4" (102mm) dia., 10" (254mm) long, 50/box, 15 lbs. (6.8kg)

CAB 301 4" (102mm) dia., 18" (457mm) long, 50/box, 18 lbs. (8.2kg)

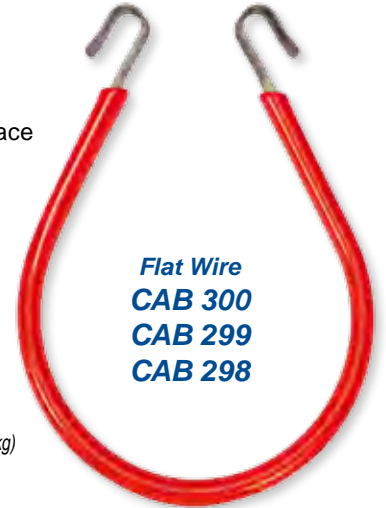

Flat Wire
CAB 300
CAB 299
CAB 298

CAB 100% Plastisol Coated Flat Wire Cable Clips

Manufactured as other flat wire cable clips but coated over the entire surface with abrasion resistant, high dielectric grade plastisol for total insulation and corrosion resistance. .591" (15mm) diameter loops.

CAB 934 2" (51mm) dia., 4" (102mm) long, 100/box, 12 lbs. (5.5kg)

CAB 932 2-5/8" (67mm) dia., 4-3/4" (121mm) long, 100/box, 15 lbs. (6.8kg)

CAB 931 3-7/8" (98mm) dia., 6-3/4" (171mm) long, 50/box, 10 lbs. (4.5kg)

CAB 933 6" (152mm) dia., 9-3/4" (248mm) long, 25/box, 9 lbs. (4.1kg)

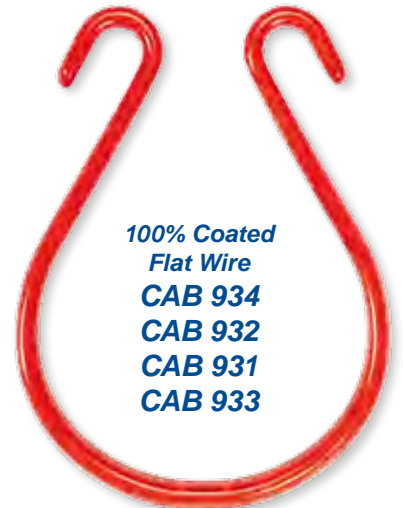

100% Coated
Flat Wire
CAB 934
CAB 932
CAB 931
CAB 933



Flat Wire
CAB 940
CAB 301

Strong, Durable CAB Hangers Provide Added Safety and Protection in Mines.

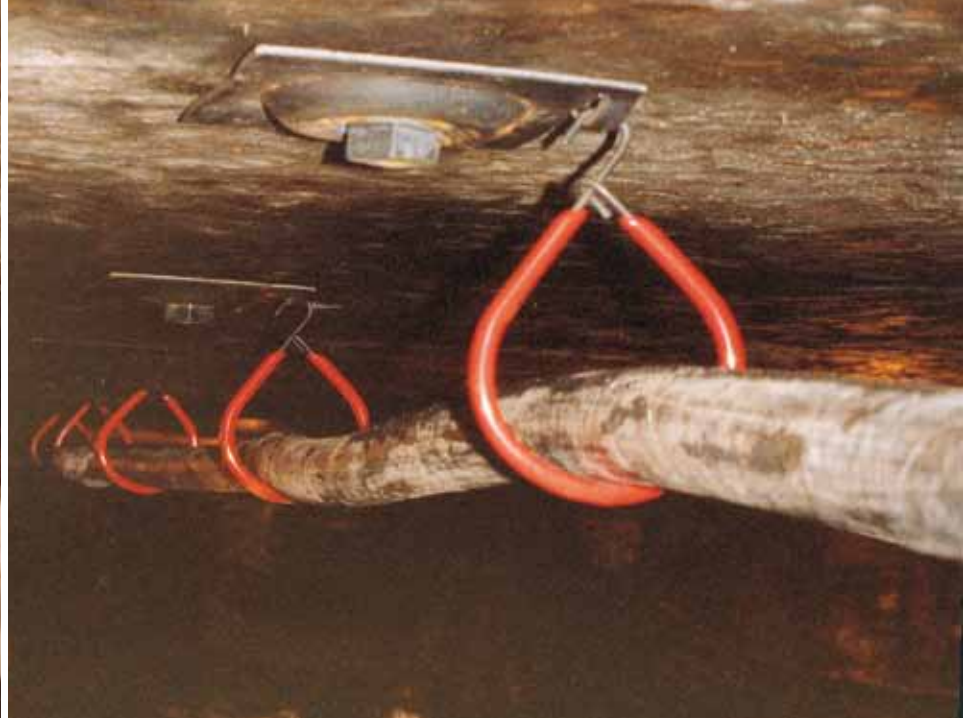

Versatile CAB Cable Clips safely suspend all types of electrical cables.

All hanger carrying surfaces are fully insulated with a tough, high dielectric grade, flame retardant plastisol coating.

CAB Latchbacks are high quality hangers designed for supporting hose, pipe and cable from roof bolt plates, spads, wire mesh or structure. Manufactured from high tensile spring steel for maximum strength with a 5/8" (16mm) diameter top installation loop. CAB 321 same as 320, but top loop is offset 90° to carrier section.

CAB 320 3-5/8" (92mm) dia., .156 (4mm) wire, 7" (178mm) long, 100/box, 15 lbs (6.8kg)

CAB 321 3-5/8" (92mm) dia., .156 (4mm) wire, 7" (178mm) long, 90° offset loop, 50/box, 9 lbs (4.1kg)

CAB 308 4-1/2" (114mm) dia., .156 (4mm) wire, 8" (203mm) long, 50/box, 9 lbs (4.1kg)

CAB 306 4-1/2" (114mm) dia., .187 (4.7mm) wire, 8" (203mm) long, 50/box, 12 lbs (5.5kg)



**Super Latchback
CAB 3704**

CAB Super Latchbacks are made from .187 (4.7mm) high tensile spring steel and feature a large capacity 4-1/2" (114mm) diameter carrier. For easier installation, hanger has extra large 1-3/8" (35mm) diameter 90° offset top installation loop.

CAB 3704 4-1/2" (114mm) dia., .187 (4.7mm) wire, 9-1/2" (241mm) long, 50/box, 13 lbs (5.9kg)



**Latchback
CAB 320
CAB 321
CAB 308
CAB 306**

For total corrosion resistance in underground applications, use CAB 100% PVC Coated Cable Clips shown on page 2 or CAB Bosserman Clips shown on page 5.

CAB® U-Hangers with Crossbars



**U-Hanger
with Standard
Crossbar**
CAB 316
CAB 335
CAB 336

CAB U-Hangers feature a locking crossbar to retain cables in the hanger and a large 7/8" (22mm) diameter top loop for easy installation. These strong hangers are made for supporting all types of cables, pipe and tubing from roof bolt plates, spads, or other structure.

The carrying surfaces of CAB U-Hangers receive a heavy coating of high dielectric grade plastisol for maximum insulation and abrasion resistance. Made from .187 (4.7mm) high carbon spring steel wire for maximum strength and carrying capacity.

CAB U-Hangers with Standard Crossbars

This is one of the most popular and versatile hangers for underground cable support. Offered in 3 standard sizes.

CAB 316 3" (76mm) dia., 4-1/2" (114mm) long, 100/box, 17 lbs. (7.7kg)

CAB 335 4" (102mm) dia., 6" (152mm) long, 50/box, 11 lbs. (5.0kg)

CAB 336 5" (127mm) dia., 7" (178mm) long, 50/box, 13 lbs. (5.9kg)

CAB U-Hangers with Safety-Tip Crossbars

Constructed the same way as standard U-Hangers but feature a rounded safety tip on the end of the crossbar. Prevents snagging during installations, when crossbars are left unlatched or in low roof conditions.

CAB 221 3" (76mm) dia., 4-1/2" (114mm) long, 100/box, 17 lbs. (7.7kg)

CAB 344 4" (102mm) dia., 5-7/8" (149mm) long, 50/box, 12 lbs. (5.5kg)

CAB 222 5" (127mm) dia., 7-1/8" (181mm) long, 50/box, 14 lbs. (6.4kg)



**U-Hanger
with Safety Tip
Crossbar**
CAB 221
CAB 344
CAB 222

CAB Bulldog Pipe Saddles

Quickly snaps on pipe to securely retain a pressurized hose or cable in fixed position on pipe. Manufactured from .187 (4.7mm) spring steel, totally plastisol coated for corrosion resistance and slippage reduction. Especially useful in methane drainage applications. Two standard sizes, other sizes available.

CAB 873 4" (102mm) dia., 100/box, 15 lbs. (6.8kg)

CAB 874 6" (152mm) dia., 50/box, 12 lbs. (5.5kg)

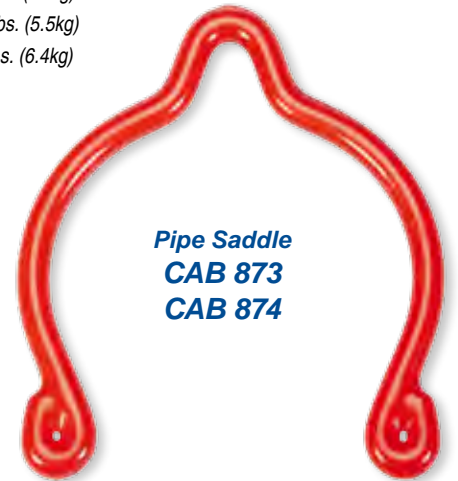

Pipe Saddle
CAB 873
CAB 874



CAB® Brattice Hangers
Install brattice cloth quickly and easily
No hammers or nails needed
Save on tire repairs and injuries

CAB 3703
CAB 7647

CAB Brattice Hangers are designed to quickly and easily suspend brattice cloth from the mine roof. Sharp offset tip keeps brattice tight to the roof. Made from .187 (4.7mm) wire, 7" (178mm) long with 1-1/8" (29mm) or 1-1/2" (38mm) diameter hole. For proper installation, hanger must be placed on end of roof bolt between the plate and the roof of the mine.

CAB 3703 1-1/8" (29mm) dia. hole, 200/box, 17 lbs. (7.7kg)

CAB 7647 1-1/2" (38mm) dia. hole, 200/box, 19 lbs. (8.6kg)



CAB® Bosserman Clips

CAB Bosserman Clips are widely respected for their superior ability to safely suspend electrical cables and wiring in a variety of underground applications. CAB Bosserman Clips feature a 100% plastisol coated high tensile spring steel body and locking arm to prevent pull out and slippage. This improved hanger combines all the advantages of steel and plastic for the highest level of performance and safety underground.



Bosserman Clips keep cables safely up and out of the way of moving equipment.



The Bosserman Clip is CAB's strongest, most corrosion resistant mine hanger.



Bosserman Clip
CAB 814 - 820
CAB 821 - 828
CAB 950 - 956



CAB® Bosserman Clips

Advantages of Bosserman Clips

1. Corrosion and rust problems are virtually eliminated due to the heavy plastisol coating over the entire metal surface of the Bosserman Clip. This rustproofing protection will outlast other typical methods of rustproofing and will result in significant cost savings and improved safety.
2. Slippage of hangers on the messenger wire is no longer a problem due to the slip resistance of the plastisol in the attachment section of the clip. Uniform spacing of hangers without this slippage will keep wires more safely up and out of the way.
3. High dielectric grade plastisol applied on 100% of the hanger surface makes the Bosserman Clip totally insulated and spark resistant. Provides for maximum safety in the suspension of electric cables and wiring in all underground applications.
4. Extra Long Styles available for running 2 cables separately from 1 messenger wire or large bundles of cables. Also available with 1" (25mm) wide saddles in the cable carrying section for extra support of cables.

Bosserman Clip 1/4" (6mm) Lock

CAB 814 1" (25mm) dia., 200/box, 13 lbs. (5.9kg)
CAB 815 2" (51mm) dia., 100/box, 13 lbs. (5.9kg)
CAB 816 3" (76mm) dia., 50/box, 9 lbs. (4.1kg)
CAB 817 4" (102mm) dia., 50/box, 16 lbs. (7.3kg)
CAB 818 5" (127mm) dia., 25/box, 9 lbs. (4.1kg)
CAB 819 6" (152mm) dia., 25/box, 10 lbs. (4.5kg)
CAB 820 8" (203mm) dia., 25/box, 13 lbs. (5.9kg)

Bosserman Clip 3/8" (10mm) Lock

CAB 821 1" (25mm) dia., 200/box, 13 lbs. (5.9kg)
CAB 822 2" (51mm) dia., 100/box, 13 lbs. (5.9kg)
CAB 823 3" (76mm) dia., 50/box, 9 lbs. (4.1kg)
CAB 824 4" (102mm) dia., 50/box, 16 lbs. (7.3kg)
CAB 825 5" (127mm) dia., 25/box, 9 lbs. (4.1kg)
CAB 826 6" (152mm) dia., 25/box, 10 lbs. (4.5kg)
CAB 828 8" (203mm) dia., 25/box, 13 lbs. (5.9kg)

Bosserman Clip 1/2" (13mm) Lock

CAB 950 1" (25mm) dia., 200/box, 13 lbs. (5.9kg)
CAB 951 2" (51mm) dia., 100/box, 13 lbs. (5.9kg)
CAB 952 3" (76mm) dia., 50/box, 9 lbs. (4.1kg)
CAB 953 4" (102mm) dia., 50/box, 16 lbs. (7.3kg)
CAB 954 5" (127mm) dia., 25/box, 9 lbs. (4.1kg)
CAB 955 6" (152mm) dia., 25/box, 10 lbs. (4.5kg)
CAB 956 8" (203mm) dia., 25/box, 13 lbs. (5.9kg)

For total corrosion resistance and insulation in above ground applications, use CAB Rings which are outlined on page 14.

CAB® Telewire Hooks

For safe support of electrical, control, communication or sensor wires.
Can be driven into timber or hung from roof bolt plates, chain, spads or cable.
Pigtail and closed loop designs offer additional safety and prevent wires from accidentally coming out of the hanger.

CAB Drive-In Telewire Hooks

Designed to be installed without a nail. Hooks have a sharp point for driving and an offset opening to prevent wires from accidentally coming out of the hook.

Packaged 200/box.

CAB 342 3/4" (19mm) dia., .156 (4mm) wire, 10 lbs. (4.5kg)

CAB 296 1-1/4" (32mm) dia., .187 (4.7mm) wire, 15 lbs. (6.8kg)

CAB 334 1-1/4" (32mm) dia., .156 (4mm) wire, 12 lbs. (5.5kg)

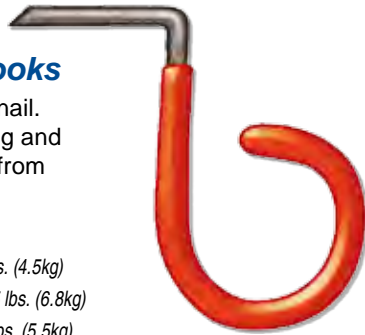

CAB 297 Telewire Hooks

Designed for installation from spad, roof bolt plate or chain. Offset opening helps retain wire in hook. Made from .187 (4.7mm) wire with 3/8" (10mm) diameter top loop offset 90° to 1-1/4" (32mm) bottom carrier.

CAB 297 1-1/4" (32mm) dia., 200/box, 15 lbs. (6.8kg)



CAB Drive-In Closed Loop Hooks

Feature a 540° insulated spiral loop which virtually guarantees that wiring will be safely retained and not accidentally vibrate or jump out of the hook. Easily installed with sharp tip drive-in point. Made from .156 (4mm) wire.

CAB 911 1-1/4" (32mm) dia., 100/box, 11 lbs. (5kg)

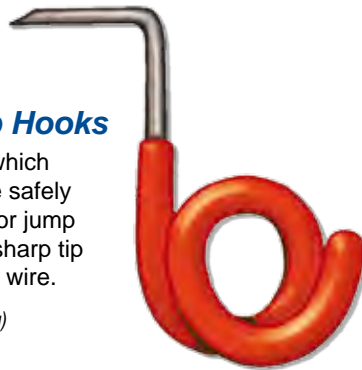

CAB 302, 311 Telewire Hooks

These J-Hooks are useful for a wide variety of hanging jobs. Can be installed from chain, roof bolt plates, spads, etc. 3/8" (10mm) diameter top loop offset 90° to 1-1/4" (32mm) carrier section. Offered in 2 wire gauges. Packaged 200/box.

CAB 302 1-1/4" (32mm) dia., .187 (4.7mm) wire, 16 lbs. (7.3kg)

CAB 311 1-1/4" (32mm) dia., .156 (4mm) wire, 11 lbs. (5kg)



CAB Closed Loop Telewire Hooks

Closed loop design prevents wires from vibrating or jumping out of the carrier section of the hook. Made from .156 (4mm) wire with 1/2" (13mm) diameter top loop offset 90° to carrier section.

CAB 908 1" (25mm) dia., 200/box, 15 lbs. (6.8kg)

CAB 912 1-1/4" (32mm) dia., 100/box, 10 lbs. (4.5kg)



CAB Jumbo Telewire Hooks

Extra capacity hooks made for those large jobs. Features same design as the popular 297 and 311 but have larger overall dimensions. Made from sturdy .187 (4.7mm) wire with a 5/8" (16mm) diameter top loop set at 90° to bottom carrier. Packaged 200/box. Available in 2 sizes.

CAB 223 1-5/8" (41mm) dia., 17 lbs. (7.7kg)

CAB 219 2" (51mm) dia., 19 lbs. (8.6kg)



CAB 340, 341 Telewire Hooks

S-Style hook features 5/8" (16mm) diameter top loop and 1-1/4" (32mm) diameter carrier loop. CAB 340 same as 341 except attachment loop set 90° to carrying area. Made from .156 (4mm) wire.

CAB 340 1-1/4" (32mm) dia., 200/box, 11 lbs. (5kg)

CAB 341 1-1/4" (32mm) dia., 200/box, 11 lbs. (5kg)



CAB 333, 339 Telewire Hooks

Feature a large 5/8" (16mm) diameter top attachment loop for easier installation. Offset opening retains wiring in support area. Available in 2 wire gauges. Packaged 200/box.

CAB 333 1-1/4" (32mm) dia., .156 (4mm) wire, 12 lbs. (5.5kg)

CAB 339 1-1/4" (32mm) dia., .187 (4.7mm) wire, 16 lbs. (7.3kg)

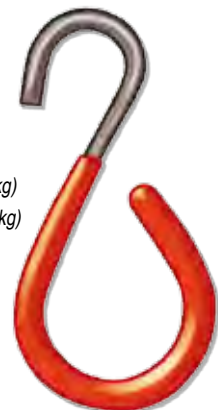

CAB® Multi Carrier Hooks

Safe system for organizing sensor, communication, control and electrical wiring. Especially useful along conveyor beltlines and when running multiple cables.

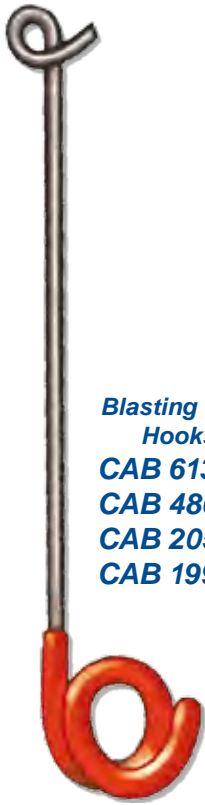

Blasting Wire Hooks
CAB 6130
CAB 4801
CAB 205
CAB 199

CAB Blasting Wire Hooks

are designed to safely isolate blasting or other wiring from the roof, electrical cables or structure. A 7/8" (22mm) diameter 540° bottom loop securely retains wires in carrier. The 1/2" (13mm) top spiral loop design prevents dislodging of hanger after installation.

CAB 6130 4" (102mm) long, 100/box, 9 lbs. (4.1kg)

CAB 4801 6" (152mm) long, 100/box, 11 lbs. (5.0kg)

CAB 205 12" (305mm) long, 50/box, 7 lbs. (3.2kg)

CAB 199 18" (457mm) long, 100/box, 18 lbs. (8.2kg)

CAB 305



CAB 305 has four 1" (25mm) diameter closed spiral loops. 1/2" (13mm) diameter top loop has closed spiral design which prevents dislodging of hanger from beltline chain or other support after installation. .156 wire (4mm), 11-3/4" (298mm) long.

CAB 305 25/box, 11 lbs. (5.0kg)

CAB 231* 25/box, 11 lbs. (5.0kg)

*Same as CAB 305 except with drive-in point for nail-in application.

CAB 4701



CAB 4701 has three 3/4" (19mm) diameter carriers and 1/2" (13mm) diameter open top loop. CAB 809 is the same except has a drive-in point. 8" (203mm) long. Made from .156 (4mm) wire.

CAB 4701 50/box, 10 lbs. (4.5kg)

CAB 809 100/box, 15 lbs. (6.8kg)

CAB 811

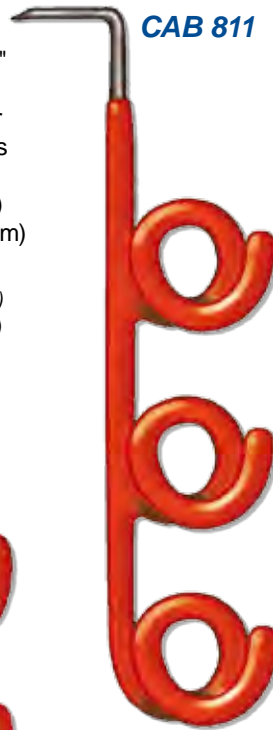

CAB 811 and 812 feature three 1-1/4" (32mm) diameter closed loop carriers. CAB 812 has 1/2" (13mm) diameter top loop for installation from plates, spads or chain. The 811 has sharp tip drive-in point for easy nailing into wood structure. Made from .156 (4mm) wire, 10-5/8" (270mm) long. Packaged 25/box.

CAB 811 10 lbs. (4.5kg)

CAB 812 10 lbs. (4.5kg)

CAB 812
(side view)



Put CAB Hangers to work in your mine!



CAB Telewire Bars

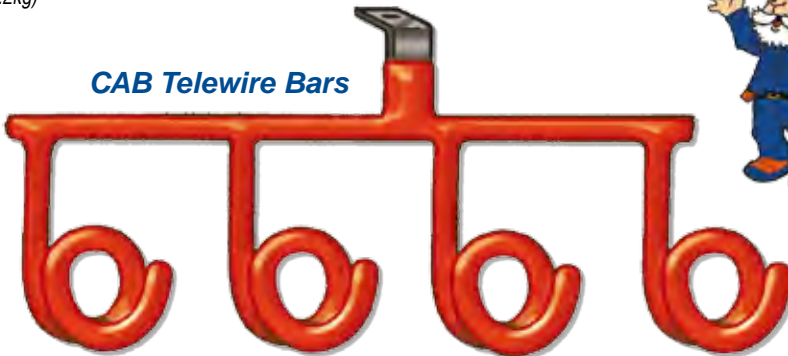

CAB Telewire Bars are heavy duty multi-carrier hangers for roof installations. Top section made from .180" x 1" (4.6 x 25.4mm) safety edge steel and 5/16" (7.9mm) round stock. Bottom carriers made any diameter in closed loop (pictured) or open loop designs. Can be made with 1 to 10 carriers, custom to your specifications.

CAB 910



CAB 910 features two 1" (25mm) diameter closed loop carriers. Ideal for above beltlines because of short 5-1/4" (133mm) length. .156 (4mm) wire with 1/2" (13mm) diameter top loop.

CAB 910 50/box, 9 lbs. (4.1kg)

CAB 813 Same design as 910 but features four 1-1/4" (32mm) diameter closed loop spirals which securely retain cables in hanger. Overall length 11" (279mm).

CAB 813 40/box, 19 lbs. (8.6kg)

CAB® Rope Hangers

Versatile hangers designed to support hose, pipe and cables in many applications. Made from 1/4" (6.4mm) flame retardant, hollow braid polypropylene rope with strong .208" (5.3mm) dia. galvanized wire hooks.

Rope Hanger
CAB 3832

Rope Hanger
CAB 988

CAB Rope Hangers are offered in any length, with any number of hooks, including heavy duty .250" (6.4mm) diameter galvanized wire hooks. Rope Hangers primarily intended for temporary use. For permanent cable support, insulated steel hangers are recommended. Standard sizes listed below. Other sizes available.

- CAB 3708** 12" (305mm) long, .208 hook, 200/box, 13 lbs. (5.9kg)
- CAB 3709** 15" (381mm) long, .208 hook, 200/box, 14 lbs. (6.4kg)
- CAB 6012** 15" (381mm) long, .208 hook/2 ea., 200/box, 24 lbs. (10.9kg)
- CAB 6018** 15" (381mm) long, .250 HD hook, 200/box, 19 lbs. (8.6 kg)
- CAB 988** 18" (457mm) long, .208 hook, 200/box, 15 lbs. (6.8kg)
- CAB 3832** 18" (457mm) long, .208 hook/2 ea., 200/box, 24 lbs. (10.9kg)
- CAB 4972** 18" (457mm) long, .250 HD hook, 200/box, 20 lbs. (9.1kg)
- CAB 6673** 18" (457mm) long, .250 HD hook/2 ea., 100/box, 32 lbs. (14.5kg)
- CAB 5965** 20" (508mm) long, 1 strand .208 hook/2 ea., 100/box, 22 lbs. (10kg)
- CAB 990** 21" (533mm) long, .208 hook, 100/box, 9 lbs.(4.1kg)
- CAB 989** 24" (610mm) long, .208 hook, 100/box, 9 lbs. (4.1kg)
- CAB 991** 36" (914mm) long, .208 hook, 100/box, 11 lbs. (5kg)
- CAB 5042** 48" (1.2m) long, .208 hook, 100/box, 7 lbs. (3.2kg)
- CAB 5041** 60" (1.5m) long, .208 hook, 100/box, 7 lbs. (3.2kg)
- CAB 7313** 72" (1.8m) long, .208 hook, 100/box, 8 lbs. (3.6kg)
- CAB 7070** 96" (2.4 m) long, .208 hook, 100/box, 11 lbs. (5kg)

CAB MRS Collapsible Hangers



MRS Hanger
CAB 6698

CAB MRS Collapsible Hangers

are designed to hang cables when mining with mobile roof supports. For improved safety, bottom two carriers of hanger collapse, allowing cables to drop to floor of mine when tension is applied. Top loop retains hanger in mine roof after bottom carriers release. This allows miners to remove cables from hangers without entering unsupported roof hazard areas. Each carrier has a safe working load of 22 pounds (10.0kg). Equally loaded, each carrier will drop cables with a weight load or tension equivalent of 70-90 lbs. (31.8-40.9kg) Made from .187 (4.7mm) low tensile strength wire, 5/8" (16mm) diameter top loop, 2-1/2" (64mm) diameter bottom carriers.

Two Carrier Hanger:

CAB 6698 7-1/2" (191mm) long, 50/box, 11 lbs. (5kg)

Single Carrier Hanger:

CAB 219 4-1/2" (114mm) long, 200/box, 19 lbs. (8.6kg)

CAB Leaky Feeder Hangers

Leaky Feeder Hanger
CAB 7719



CAB Leaky Feeder Hangers

are designed to safely and securely hang leaky feeder cable from roof of mine. Can help to reduce interference and improve signal strength by adding spacing between steel mesh or roof structure and cable. Durable 1-1/2" (38mm) wide polypropylene webbing with heavy duty top hook. Quick and easy to use. Webbing snugs down on cable to provide safe 1-1/2" (38mm) wide surface area to hold cable firmly in position.

CAB 7719 10" (254mm) long, 100/box, 9 lbs. (4.1kg)

CAB 7720 15" (381mm) long, 100/box, 10 lbs. (4.5kg)

CAB 7721 20" (508mm) long, 100/box, 11lbs. (5kg)

CAB 903

CAB 905

CAB Plastic Telewire Hooks

Made from .085 x 1" (2.2 x 25.4mm) extruded PVC channel. Designed to hang from messenger wire or bellline structure. 5/8" (16mm) wide carriers. 15/16" (24mm) top hole. 1/4" (6.4mm) nylon nuts and bolts.



CAB 904

CAB 903 200/box, 8 lbs. (3.6kg)

CAB 904 with 90° offset, 200/box, 8 lbs. (3.6kg)

CAB 905 2 carrier, 50/box, 7 lbs. (3.2kg)

CAB 906 3 carrier, 50/box, 9 lbs. (4.1kg)

CAB 909 4 carrier, 50/box, 12 lbs. (5.5kg)

CAB® J-Hooks

Safe, strong support for electrical cables, hoses and pipes. CAB J-Hooks are made from .180" x 1" (4.6 x 25.4 mm) safety edge steel, with a heavy coat of plastisol for added protection in higher voltage and heavier load applications. Keyhole feature useful for hanger adjustment or removal. Sizes up to 12" (305mm) diameter.

CAB Standard J-Hooks

Safe, strong supports for sidewall applications. Keyhole has 1/2" (13mm) opening and 5/16" (8mm) slot. Made from safety edge steel.

- CAB 343** 1-1/2" (38mm) dia., 5-1/2" (140mm) long, 100/box, 47 lbs. (21.4kg)
- CAB 347** 3" (76mm) dia., 5-1/2" (140mm) long, 50/box, 29 lbs. (13.2kg)
- CAB 349** 4" (102mm) dia., 6-3/4" (171mm) long, 25/box, 18 lbs. (8.2kg)
- CAB 350** 5" (127mm) dia., 9-5/8" (244mm) long, 25/box, 23 lbs. (10.5kg)

CAB Double J-Hooks

For hanging multiple cables from roof. 3" (76mm) diameter hooks with 5/8" (16mm) diameter top loop. CAB 213 and 155 top loop made from .187 (4.7mm) diameter wire; CAB 156 and CAB 4691 from .250" (6.4mm) wire.

- CAB 213** 6" (152mm) long, 25/box, 31 lbs. (14.1kg)
- CAB 155** 12" (305mm) long, 25/box, 35 lbs. (15.9kg)
- CAB 156** 30" (762mm) long, 25/box, 41 lbs. (18.6kg)
- CAB 4691** 36" (914mm) long, 10/box, 40 lbs. (18.2kg)

CAB Side Mount Hangers

Heavy duty supports designed to carry multiple cables in high corrosive environments. Carriers are 3" (76mm) diameter. Can be custom made with any number or size carriers required.

- CAB 6958** 1 carrier, 8" (203mm) long, 25/box, 28 lb. (12.7kg)
- CAB 6959** 2 carrier, 14-1/2" (368mm) long, 10/box, 24 lb. (10.9 kg)
- CAB 5133** 3 carrier, 20" (508mm) long, 10/box, 32 lb. (14.5kg)
- CAB 6681** 4 carrier, 26" (660mm) long, 5/box, 22 lb. (10kg)
- CAB 6704** 4 carrier, 26" (660mm) long, custom heavy duty style

CAB Drive-In J-Hooks

Feature sharp tip for driving, an installation hole in the drive-in shaft and a special detent to resist pullout. Packaged 25/box.

- CAB 353** 3" (76mm) dia., 5" (127mm) long, 17 lbs. (7.7kg)
- CAB 462** 4" (102mm) dia., 7" (178mm) long, 21 lbs. (9.5kg)
- CAB 479** 5" (127mm) dia., 8" (203mm) long, 30 lbs. (13.6 kg)

CAB Stacked J-Hooks

Heavy duty 2-carrier hangers for supporting pipe and cables from roof, side or structure. Made from .180 x 1" (4.6 x 25.4mm) safety edge steel and .187 (4.7mm) high carbon wire. 1-3/8" (35mm) diameter top loop.

- CAB 965** 1-1/2" (38mm) dia., 9-1/2" (241mm) long, 25/box, 29 lbs. (12.3kg)
- CAB 966** 3" (76mm) dia., 13" (330mm) long, 10/box, 16 lbs. (7.3kg)
- CAB 6188** 3" (76mm) dia., 30" (762mm) long, 25/box, 44 lbs. (20.0kg)

CAB Loop Top J-Hooks

Made with 1-3/8" (35mm) diameter top loop for versatility in hanging from roof or other structure.

- CAB 928** 3" (76mm) dia., 6-1/2" (165mm) long, 50/box, 32 lbs. (14.5kg)
- CAB 4501** 4" (102mm) dia., 8" (203mm) long, 25/box, 20 lbs. (9.1kg)

Double
J-Hook
CAB 213
CAB 155
CAB 156
CAB 4691

Side Mount
Hanger
CAB 5133
CAB 6681
CAB 6704

Standard
J-Hook
CAB 343
CAB 347
CAB 349
CAB 350

Stacked J-Hook
CAB 965
CAB 966
CAB 6188

Drive-In
J-Hook
CAB 353
CAB 462
CAB 479

Loop Top
J-Hook
CAB 928
CAB 4501

CAB® J-Hooks with Extensions

Made from .180"x1" (4.6 x 25.4mm) wide safety edge steel with 1/4" (6.4mm) diameter round wire extension for easy installation. All carriers are 3" (76mm) diameter with heavy plastisol coating for protection of cables. Top loop is 1-1/2" (38mm) diameter. Single, double, triple and other configurations available.

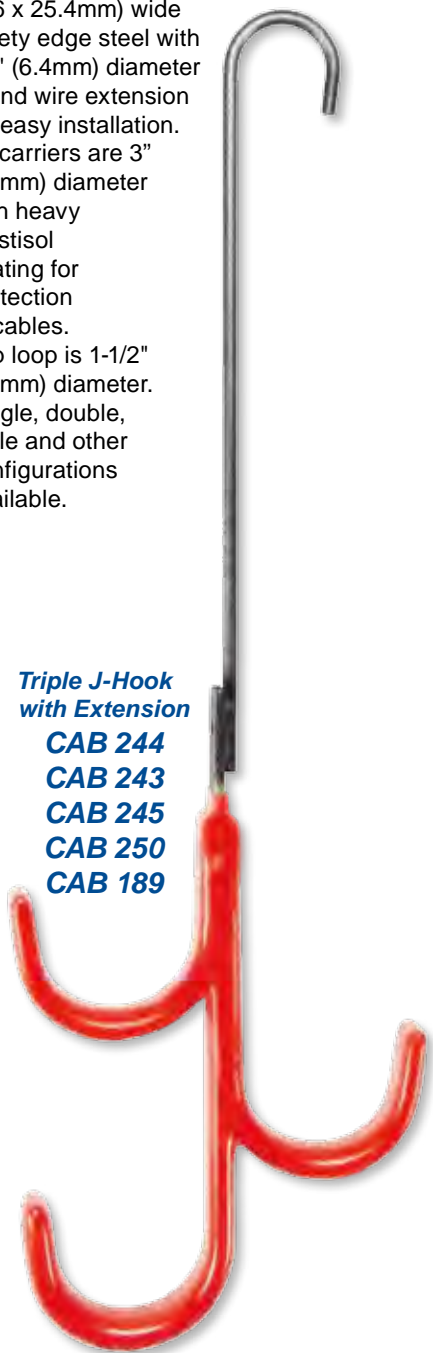

Triple J-Hook with Extension

- CAB 244**
- CAB 243**
- CAB 245**
- CAB 250**
- CAB 189**

1 Carrier:

- CAB 7379** 18" (457mm) long, 25/box, 22 lbs. (10kg)
- CAB 183** 36" (914mm) long, 25/box, 28 lbs. (12.7kg)

2 Carrier:

- CAB 7558** 30" (762mm) long, 25/box, 45 lbs. (20.5kg)

3 Carrier:

- CAB 244** 14" (356mm) long, 10/box, 22 lbs. (10kg)
- CAB 243** 24" (610mm) long, 10/box, 25 lbs. (11.4kg)
- CAB 245** 36" (914mm) long, 10/box, 27 lbs. (12.3kg)
- CAB 250** 48" (1.2m) long, 10/box, 30 lbs. (13.6kg)
- CAB 189** 72" (1.8m) long, 10/box, 31 lbs. (14.1kg)

CAB® Longwall Hangers

Heavy duty 8 carrier hanger designed to improve safety by organizing all types of cables and hoses used in longwall operations.

Longwall Hanger saves time and money because it is quick and easy to install and load with cables.

CAB's heavy plastic coating makes this hanger much safer to use than other types of fabricated bare metal hangers.

Made from sturdy .180" x 1" (4.6 x 25.4mm) safety edge steel with a strong 1/4" (6.4mm) diameter swivel hook at the top.

Also available with 12" (305mm) long extension hook at top for reduced lifting in higher roof areas. All carriers are 3" (76mm) diameter and totally coated with 90 mils (2.3mm) of high dielectric grade plastisol that has a 400-volt per mil (.03mm) dielectric breakdown strength. Coating is also very abrasion resistant and flame retardant.

CAB 154 24" (610mm) long, 10/box, 60 lbs. (27.3kg)

CAB 7406 34" (864mm) long, 10/box, 64 lbs. (29.1kg)

Available in 4 and 6 Carrier styles.

Also available with extensions for high roof areas.

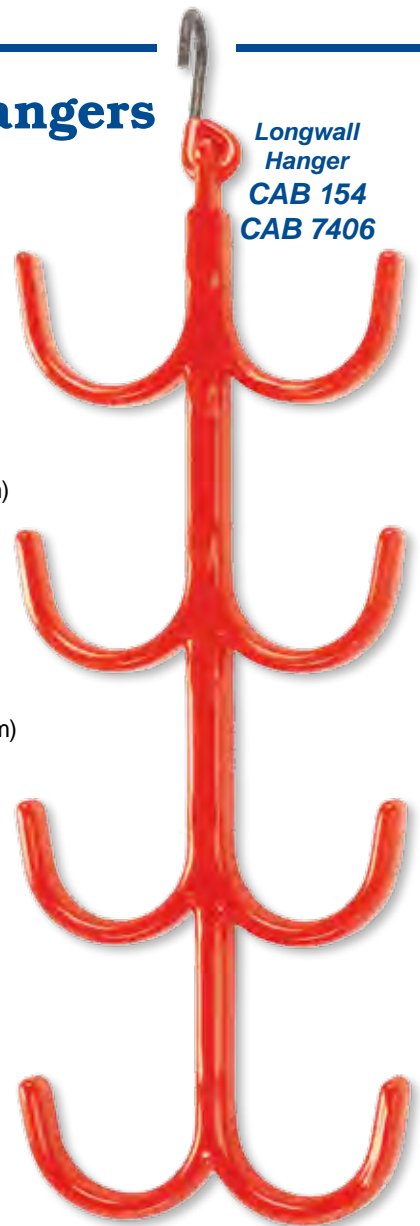

**Longwall Hanger
CAB 154
CAB 7406**



**Jumbo S-Hook
CAB 7338**

CAB Jumbo S-Hooks

Designed for all types of heavy duty hanging applications around the mine. Manufactured from strong 1/2" (13mm) diameter round stock with heavy plastisol coating over 100% of the surface. Large capacity 4-1/2" (114mm) diameter bottom carrier and 2-1/4" (57mm) top loop.

CAB 7338 10-1/2" (267mm) long, 10/box, 17 lbs. (7.7kg)

CAB U-Bolts

Made in a wide variety of sizes and styles to safely retain and bundle cables and hoses. Especially useful in longwall operations. Manufactured from any diameter threaded round stock with a heavy plastisol coating for maximum safety and protection. Contact CAB for standard sizes or to request custom dimensions. Nuts are optional.

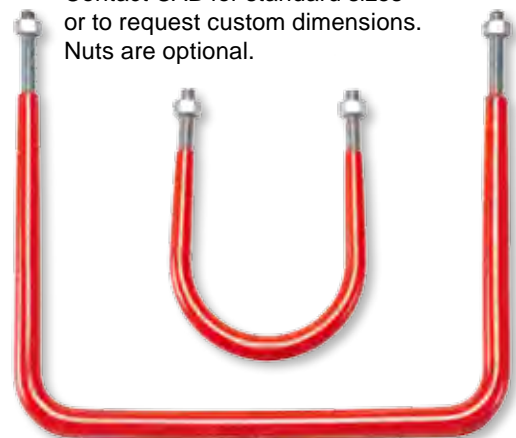

These CAB hangers are really tough! Plus we offer custom sizes and extensions.



CAB® Heavy Duty Round Stock Hangers

Designed To Carry Larger Loads

CAB Bullhorn Hangers

Heavy duty hangers made from strong 3/8" (10mm) diameter round stock with a 1/2" (13mm) diameter top loop. Bottom carriers are 5" (127mm) diameter, heavily coated with high dielectric grade plastisol for added safety and protection. Custom sizes available for high roof areas.

2 Carrier Bullhorn Hanger
CAB 143
CAB 144
CAB 141

CAB Bullhorn Hangers:

2 Carrier, top loop offset 90° to carrier:

CAB 143 18" (457mm) long, 10/box, 20 lbs. (9.1kg)

CAB 144 24" (610mm) long, 10/box, 21 lbs. (9.5kg)

CAB 141 30" (762mm) long, 10/box, 23 lbs. (10.5kg)

3 Carrier:

CAB 7628 19" (483mm) long, 15/box, 34lbs. (15.5kg)

4 Carrier:

CAB 7683 19" (483mm) long, 15/box, 41lbs. (18.6kg)

Also available with swivel top hook for faster installation.

4 Carrier Bullhorn Hanger
CAB 7683

CAB Super Duty Hangers

Made from strong 1/2" (13mm) diameter round stock to carry heavier loads. CAB 5653 is a 5-carrier hanger designed to handle heavy pipes, hoses and cables. Features three 3" (76mm) diameter and two 4" (102mm) diameter carriers with 2" (51mm) diameter top loop. Custom styles available.

CAB 5653 57" (1.4m) long

Super Duty Hanger
CAB 5653

CAB 228

CAB 228

Versatile 3 carrier hanger with 3" (76mm) diameter carriers. Made from strong 1/4" (6.4mm) diameter round wire with top spiral loop for secure attachment to plates, mesh or structure. Packaged 50/box.

CAB 228 1/2" (13mm) dia. top loop, 18" (457mm) long, 47 lbs. (21.4kg)

CAB 188 1-1/2" (38mm) dia. top loop, 18" (457mm) long, 47 lbs. (21.4kg)

CAB® Webbing Belts, Straps and Hangers

Strong and Versatile for Hanging All Types of Pipe and Cable

CAB Webbing Hangers

Made for the heavy-duty support of pipe and cable in underground mines and tunnels. Custom offset hooks are securely sewn into the ends of strong 1-1/2" (38mm) wide polypropylene webbing. Available with standard non-welded or heavy-duty welded hooks. Size measured from end of hooks with webbing fully extended. Common sizes listed below. Custom sizes available.

Standard 3/16" (5mm) Diameter Hooks:

- CAB 897** 15" (381mm) long, 100/box, 15 lbs. (6.8kg)
- CAB 898** 23" (584mm) long, 100/box, 16 lbs. (7.3kg)
- CAB 900** 30" (762mm) long, 50/box, 9 lbs. (4.1kg)
- CAB 902** 36" (914mm) long, 50/box, 10 lbs. (4.5kg)
- CAB 6820** 48" (1.2m) long, 50/box, 12 lbs. (5.5kg)

Heavy Duty Welded 3/16" (5mm) Diameter Hooks:

- CAB 893** 15" (381mm) long, 100/box, 15 lbs. (6.8kg)
- CAB 894** 23" (584mm) long, 100/box, 17 lbs. (7.7kg)
- CAB 895** 30" (762mm) long, 50/box, 9 lbs. (4.1kg)
- CAB 896** 36" (914mm) long, 50/box, 10 lbs. (4.5kg)
- CAB 6819** 48" (1.2m) long, 50/box, 13 lbs. (5.9kg)

CAB Double D-Ring Webbing Hangers

Strong, versatile hangers designed for supporting hose, pipe and cable in a variety of underground applications. Double D-rings allow for quick and easy adjustment of hanger length to keep lines at the desired height. Hanger made from 1-1/2" (38mm) wide orange polypropylene webbing. Top hook and D-rings welded and hot-dipped galvanized for extra strength and durability. Available in lengths of 2' to 20' (610mm to 6.1m) in 1' (305mm) increments. Common sizes listed below. For heavier loads use 1/4" (6.4mm) top hook. Size measured by overall length of webbing and hook before assembly.

Standard 3/16" (5mm) Diameter Top Hook:

- CAB 834** 2 ft. (610mm) long, 50/box, 10 lbs. (4.5kg)
- CAB 835** 3 ft. (914mm) long, 50/box, 11 lbs. (5kg)
- CAB 836** 4 ft. (1.2m) long, 50/box, 12 lbs. (5.5kg)
- CAB 837** 5 ft. (1.5m) long, 50/box, 13 lbs. (5.9kg)
- CAB 838** 6 ft. (1.8m) long, 50/box, 14 lbs. (6.3kg)

Heavy Duty 1/4" (6.4mm) Diameter Top Hook:

- CAB 844** 2 ft. (610mm) long, 50/box, 13 lbs. (5.9kg)
- CAB 845** 3 ft. (914mm) long, 50/box, 14 lbs. (6.4kg)
- CAB 846** 4 ft. (1.2m) long, 50/box, 16 lbs. (7.3kg)
- CAB 847** 5 ft. (1.5m) long, 50/box, 18 lbs. (8.2kg)
- CAB 848** 6 ft. (1.8m) long, 50/box, 20 lbs. (9.1kg)



CAB Webbing Belts and Straps

Heavy Duty Styles for Bundling Hoses and Cables

Belts made from black or orange polypropylene webbing in three widths: 1", 1-1/2" or 2" (25mm, 38mm or 51mm). Choice of high quality corrosion resistant buckles in Double-D, Standard, Cam and Ratchet styles. Especially useful in longwall applications. Common sizes listed below. Custom sizes available.

Cam Buckle:

- CAB 6127** 1" x 2 ft. (25mm x 610mm) long, 50/box, 6 lbs. (2.7kg)
- CAB 6995** 1" x 3 ft. (25mm x 914mm) long, 50/box, 8 lbs. (3.6kg)
- CAB 7299** 1" x 4 ft. (25mm x 1.2m) long, 50/box, 9 lbs. (4.1kg)
- CAB 3707** 2" x 4 ft. (51mm x 1.2m) long, 25/box, 18 lbs. (8.2kg)

Standard Buckle:

- CAB 3715** 1-1/2" x 4 ft. (38mm x 1.2m) long, 50/box, 9 lbs. (4.1kg)

Double-D Ring Buckle:

- CAB 852** 1-1/2" x 2 ft. (38mm x 610mm) long, 50/box, 8 lbs. (3.6kg)
- CAB 853** 1-1/2" x 3 ft. (38mm x 914mm) long, 50/box, 9 lbs. (4.1kg)
- CAB 854** 1-1/2" x 4 ft. (38mm x 1.2m) long, 50/box, 10 lbs. (4.5kg)
- CAB 855** 1-1/2" x 5 ft. (38mm x 1.5m) long, 50/box, 11 lbs. (5kg)

Ratchet Style:

- CAB 3827** 1" x 12 ft. (25mm x 3.7m) long, 25/box, 25 lbs. (11.4kg)
- CAB 6960** 2" x 6 ft. (51mm x 1.8m) long, 10/box, 25 lbs. (11.4kg)
- CAB 6472** 2" x 12 ft. (51mm x 3.7m) long, 10/box, 28 lbs. (12.7kg)



CAB® Vent Tube Hangers

Safer, Easier to Install and More Cost Effective than Chain or Tie Wire



**Webbing Vent Tube Hanger
CAB 838**

**Wire Reinforced Webbing Vent Tube Hanger
CAB 7286
CAB 6570**

**Rope Vent Tube Hanger
CAB 6469
CAB 6686**

**Webbing Vent Tube Hanger without Wire Insert
CAB 7866**

CAB offers three styles of high quality hangers designed to safely suspend vent tubing. All are easier to use, more cost effective and safer than chain or tie wire. Webbing styles are made from 1-1/2" (38mm) wide polypropylene webbing with two heavy duty 1/4" (6.4mm) S-hooks and quick release buckle for easy adjustment.

Longer styles available with wire inserts sewn in the webbing for easy hook up in high roof areas. Rope style has spliced S-hook on one end and floating hook with line tightener on other end. After installation of hooks, tightener is easily adjusted on rope for proper positioning of vent tubing. Available in 1/4" (6.4mm) and 5/16" (8mm) diameter rope styles. Sizes measured by overall length fully extended. Custom sizes available.

Webbing Style Hangers:

- CAB 838** 6 ft. (1.8m) long, 50/box, 16 lbs. (7.3kg)
- CAB 7286** 8 ft. (2.4m) long, 15" (381mm) wire insert, 25/box, 19 lbs. (8.6kg)
- CAB 6570** 8 ft. (2.4m) long, 21" (533mm) wire insert, 25/box, 19 lbs. (8.6kg)
- CAB 7866** 6 ft. (1.8m) long, no wire insert, 25/box, 15 lbs. (6.8kg)

Rope Style Hangers:

- CAB 6469** 1/4" (6.4mm) rope, 10 ft. (3m) long, 25/box, 7 lbs. (3.2kg)
- CAB 6686** 5/16" (8mm) rope, 10 ft. (3m) long, 25/box, 12 lbs. (5.5kg)

CAB® Lifeline Hangers

Designed to Securely Hang Rope or Aircraft Cable Lifeline at Desired Height in Any Mine



Elastic

Aircraft Cable

Rope

Rope Quick Release

Rope and Aircraft Cable Hangers quickly attach to lifeline and have a strong hook for attachment to plates, mesh or roof structure. Elastic hangers are especially useful in crosscuts; they stretch 5 times their original length to lower lifeline during use and return it to original height after use. Quick-Release Hangers have a release pin that attaches to hanger hole or edge of plate. They can be quickly pulled off plates to drop lifeline for emergency escape. Standard sizes listed below. Custom and longer sizes available.



CAB Aircraft Cable Hanger with CAB Lifeline Marker



CAB Rope Hanger with CAB Lifeline Marker

Elastic Lifeline Hangers:

- CAB 7335** 1 ft. (305mm) long, 25/box, 4 lbs. (1.8kg)
- CAB 7332** 2 ft. (610mm) long, 25/box, 5 lbs. (2.3kg)
- CAB 7336** 3 ft. (914mm) long, 25/box, 6 lbs. (2.7kg)
- CAB 7337** 4 ft. (1.2m) long, 25/box, 6 lbs. (2.7kg)

Aircraft Cable Lifeline Hangers:

- CAB 7165** 1 ft. (305mm) long, 25/box, 5 lbs. (2.3kg)
- CAB 7166** 2 ft. (610mm) long, 25/box, 6 lbs. (2.7kg)
- CAB 7167** 3 ft. (914mm) long, 25/box, 7 lbs. (3.2kg)
- CAB 7168** 4 ft. (1.2m) long, 25/box, 8 lbs. (3.6kg)
- CAB 7169** 5 ft. (1.5m) long, 25/box, 9 lbs. (4.1kg)
- CAB 7170** 6 ft. (1.8m) long, 25/box, 10 lbs. (4.5kg)

Rope Loop Lifeline Hangers:

- CAB 3708** 1 ft. (305mm) long, 200/box, 14 lbs. (6.4kg)
- CAB 989** 2 ft. (610mm) long, 100/box, 9 lbs. (4.1kg)
- CAB 991** 3 ft. (914mm) long, 100/box, 12 lbs. (5.5kg)
- CAB 5042** 4 ft. (1.2m) long, 50/box, 7 lbs. (3.2kg)
- CAB 5041** 5 ft. (1.5m) long, 50/box, 8 lbs. (3.2kg)
- CAB 7313** 6 ft. (1.8m) long, 50/box, 8 lbs. (3.6kg)

Rope Quick Release Lifeline Hangers:

- CAB 7684** 1 ft. (305mm) long, 100/box, 2 lbs. (0.9kg)
- CAB 7685** 2 ft. (610mm) long, 100/box, 3 lbs. (1.4kg)
- CAB 7686** 3 ft. (914mm) long, 100/box, 3 lbs. (1.4kg)
- CAB 7687** 4 ft. (1.2m) long, 100/box, 4 lbs. (1.8kg)
- CAB 7688** 5 ft. (1.5m) long, 100/box, 5 lbs. (2.3kg)
- CAB 7689** 6 ft. (1.8m) long, 100/box, 5 lbs. (2.3kg)

Additional rope hangers on page 8.

CAB® Cable Rings & Saddles

Industry Favorite for Safe, Strong Support of Aerial Cables

CAB Cable Rings provide maximum strength and safety for the support of all types of aerial cables. Rings are manufactured from galvanized steel, copper clad steel or type 316 stainless steel to withstand the most corrosive environments. For added safety and protection, any style ring can be totally insulated with a tough, 80 mil (2mm) coating of high dielectric grade PVC plastisol.



CAB PVC coated Rings and Saddles are extremely resistant to corrosion and act as a mini-cable tray system for cables.

For maximum strength, CAB Cable Rings are manufactured from high tensile spring steel in rolled flat wire form. This high quality material provides a smooth, flat surface for the support of cables and rounded edges for the protection of cable jackets. This advanced roll-form design, combined with the strong spring temper of the wire, provides a tight, secure attachment of the cable ring to the messenger wire.



CAB Cable Ring Saddles provide a 1" wide load-bearing area for extra support and protection of cables.

CAB Cable Rings are manufactured in standard, medium and long styles. Designed to tightly fit on an exact messenger wire size to prevent slippage. Medium and long style rings have extra length for bundles of cables or for running several cables independently from same messenger wire. Recommended spacing for ring sizes 1-1/2" through 2-1/2" (38mm through 64mm) is 15" to 20" (381mm to 508mm). Recommended spacing for ring sizes 3" through 6" (76mm through 152mm) is 12" to 15" (305mm to 381mm). Exact spacing varies depending on type of cable, nature of installation and loading requirements. When ordering cable rings, specify size, material, style and size of messenger strand.



CAB Rings are recommended for aerial cables in plants, mills, tunnels, open pit mines and pipeline projects.



CAB's Award Winning PVC coated Rings and Saddles have a heavy coating of high dielectric grade, UV stabilized PVC plastisol.



Cables can be run separately by using CAB's standard and long style rings.

CAB Sizing Guide

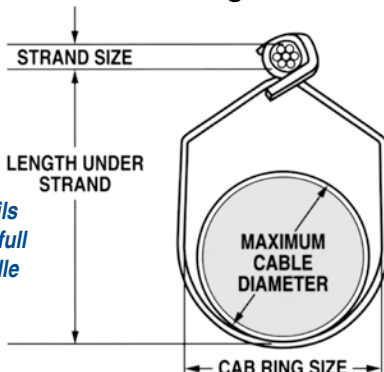

For more details ask for CAB's full Ring and Saddle brochure!

Standard Style CAB Rings

Medium and long styles also available.

Ring Diameter	Maximum Cable Diameter	Length Under Strand	Standard Rings Packaging	Standard Rings Weight/Box	PVC Coated Rings Packaging	PVC Coated Rings Weight/Box
1-1/2" (38mm)	1-1/8" (29mm)	2-1/2" (64mm)	500/box	25 lb. (11.4kg)	250/box	18 lb. (8.2kg)
2" (51mm)	1-1/2" (38mm)	2-7/8" (73mm)	250/box	19 lb. (8.6kg)	100/box	10 lb. (4.5kg)
2-1/2" (64mm)	2" (51mm)	3-1/2" (89mm)	250/box	26 lb. (11.8kg)	100/box	12 lb. (5.5kg)
3" (76mm)	2-1/4" (57mm)	4-1/8" (105mm)	100/box	12 lb. (5.5kg)	100/box	18 lb. (8.2kg)
3-1/2" (89mm)	2-5/8" (67mm)	4-1/2" (114mm)	100/box	13 lb. (5.9kg)	100/box	21 lb. (9.5kg)
4" (102mm)	3" (76mm)	5" (127mm)	100/box	19 lb. (8.6kg)	50/box	14 lb. (6.4kg)
4-1/2" (114mm)	3-1/2" (89mm)	5-1/2" (140mm)	100/box	19 lb. (8.6kg)	50/box	15 lb. (6.8kg)
5" (127mm)	4" (102mm)	6-1/4" (159mm)	50/box	11 lb. (5.0kg)	50/box	16 lb. (7.3kg)
6" (152mm)	5" (127mm)	7-1/4" (184mm)	50/box	12 lb. (5.5kg)	50/box	18 lb. (8.2kg)

CAB® Cable Pullers

Made for the Tough Job of Pulling Trailing Cables in Underground and Open Pit Mines

CAB Cable Pullers are far safer than alternatives such as chain and hemp rope. They are very effective in safety programs designed to reduce mine accidents and back injuries.

Note: Cable Pullers are not designed for lifting.

**Insulated
Steel Cable Puller
CAB 878
CAB 879**

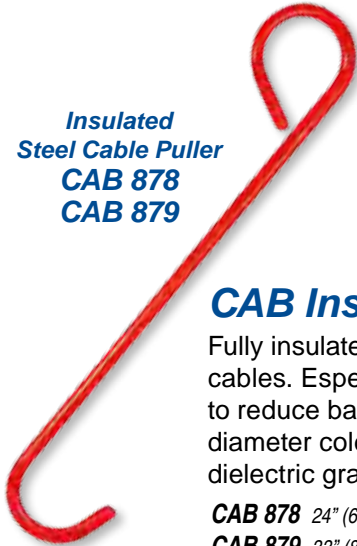

CAB Insulated Steel Cable Pullers

Fully insulated steel pull hooks for manually moving trailing cables. Especially useful in safety programs designed to reduce back injuries. Manufactured from 3/8" (10mm) diameter cold rolled steel with heavy coating of high dielectric grade plastisol for added protection.

CAB 878 24" (610mm) pull hook, 6/box, 12 lbs. (5.5kg)

CAB 879 33" (838mm) pull hook, 6/box, 14 lbs. (6.4kg)

**More effective
at gripping cables
than slings...
lower cost, too!**



CAB Webbing Cable Pullers

Made from heavy duty polypropylene webbing that provides a wide support area for pulling cables. More cost effective than slings and the webbing is not as stiff, so they provide more effective gripping and holding of cables without slippage. For added versatility, one end loop is 11" (279mm) long; the other is 14" (356mm) long. Bright yellow color provides high visibility.

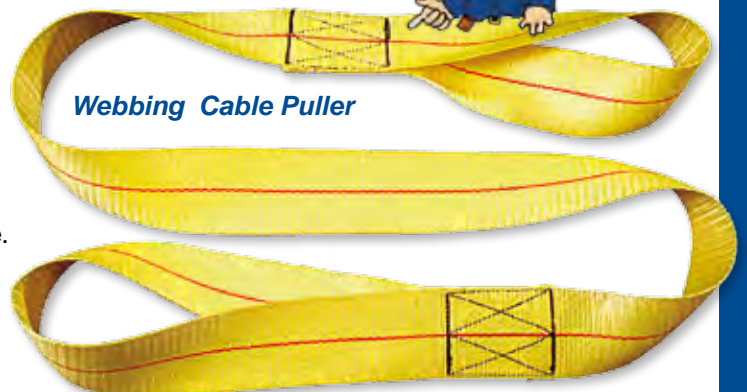

Webbing Cable Puller

2" (51mm) Wide Webbing:

CAB 6371 5 ft. (1.5m) long, 10/box, 6 lbs. (2.7kg)

CAB 6372 6 ft. (1.8m) long, 10/box, 7 lbs. (3.2kg)

CAB 6370 8 ft. (2.4m) long, 10/box, 9 lbs. (4.1kg)

CAB 6373 10 ft. (3.0m) long, 10/box, 12 lbs. (5.5kg)

3" (76mm) Wide Webbing:

CAB 6323 5 ft. (1.5m) long, 10/box, 10 lbs. (4.5kg)

CAB 6324 6 ft. (1.8m) long, 10/box, 10 lbs. (4.5kg)

CAB 6314 8 ft. (2.4m) long, 10/box, 13 lbs. (5.9kg)

CAB 6325 10 ft. (3.0m) long, 10/box, 17 lbs. (7.7kg)

CAB Rope Cable Pullers

Made from strong 7/8" (22mm) diameter hollow braid polypropylene rope. Heavy duty spliced knot on both ends prevents pull-out and provides secure 4" (102mm) end loops.

CAB 5142 7/8" (22mm) rope, 5 ft. (1.5m) long, 10/box, 10 lbs. (4.5kg)

CAB 6009 7/8" (22mm) rope, 8 ft. (2.4m) long, 10/box, 12 lbs. (5.5kg)

CAB 7258 7/8" (22mm) rope, 10 ft. (3m) long, 10/box, 14 lbs. (6.4kg)

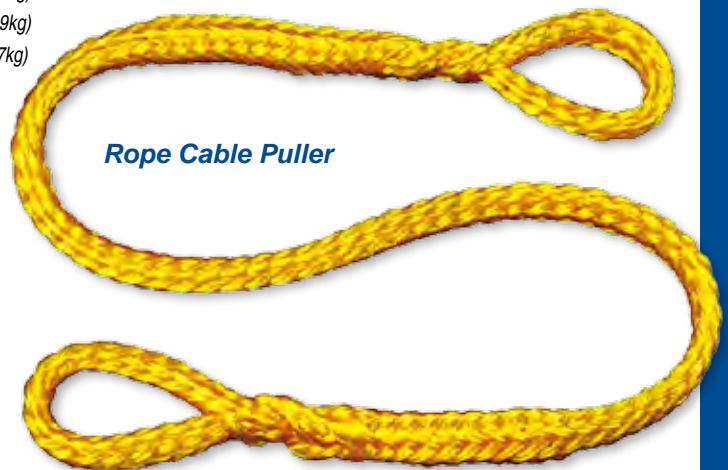

Rope Cable Puller



**Heavy Duty
Webbing
Hanger
CAB 7630**



Available with
heavy duty
hooks.

CAB Heavy Duty Webbing Hangers

Made for hanging PVC pipe in underground applications. 4" (102mm) wide black polypropylene webbing with 3" (76mm) loops on each end. Hanger pictured has folded loops for double thickness when hanging with chain. Also available with 1/4" (6.4mm) or 3/8" (10mm) diameter wire hooks on each end for hanging from plates or structure.

CAB 7630 30" (762mm) long, no hooks, 50/box, 11 lbs. (5kg)

CAB 830 41" (1m) long, 1/4" (6.4mm) dia. wire hooks, 1/2" (13mm) top loop, 25/box, 15 lbs. (6.8kg)

CAB 831 35" (889mm) long, 3/8" (10mm) dia. wire hooks, 3/4" (19mm) top loop, 25/box, 37 lbs. (16.8kg)

CAB 832 41" (1m) long, 3/8" (10mm) dia. wire hooks, 3/4" (19mm) top loop, 25/box, 39 lbs. (17.7kg)

CAB® LIFELINE

Leading the Way to Safety Since 1985



CAB Lifeline features large, heavy duty solid cones for maximum strength, safety and durability. Pictured here with aircraft cable Lifeline.

CAB Directional Indicators

CAB directional indicators are molded in a large, heavy duty solid cone. The cone size and shape is specifically designed to quickly identify proper direction of travel and to prevent a handgrip from being broken when in actual use. CAB Lifeline is hand constructed under rigid quality control by feeding Lifeline through the center of all cones, which are then firmly attached to the Lifeline with aircraft cable hardware. This prevents directional cones from being dislodged, tampered with or removed from the Lifeline. Other lifelines on the market use small cones that make it hard to tell proper direction of travel or cones that easily unsnap and fall off, even in normal use.



CAB Color Coded Directional Indicator Cones

CAB directional cones have 6 reflective bands for high visibility. All cones are securely fastened to Lifeline with aircraft cable hardware. Cannot be accidentally dislodged or removed. Reflective bands available on entire surface or tapered surface only.



CAB Extra High Visibility Lifeline is easily seen from any direction in escapeways. Lifeline markers hang vertically so they can be seen for long distances up and down escapeways. Markers are flexible so miners' hands can slide easily over them.

CAB Lifeline in Standard and Extra High Visibility Styles

CAB Standard Lifeline has 2" (51mm) wide reflective bands applied at 25 foot (7.6m) intervals between cones.

CAB Extra High Visibility Lifeline meets increasing safety standards with 2" x 4" (51mm x 102mm) or 2" x 8" (51mm x 203mm) reflective markers installed at 25 foot (7.6m) intervals between cones.

All CAB markers hang vertically and are easily seen from any direction in the escapeway. Because of their firm attachment to the Lifeline with aluminum stop sleeves, they stay oriented to show proper direction of escape at all times. Can be 1 or 2-sided in the same or different colors.

CAB's sturdy, retroreflective vinyl markers are the most brilliant on the market. They won't crack, shatter or fall off the Lifeline as other hard plastic reflectors do.



CAB Markers available in double length, extra high visibility style, as pictured above.

Now for longwall operations... Interchangeable Velcro Markers

CAB Lifeline with Velcro Markers is designed for mines that change color of Lifeline after longwall operations.

Made from strong polypropylene webbing with velcro on one side. High visibility 2" x 6" (51mm x 152mm) reflective markers with velcro backer (sold separately) are quick and easy to attach and change later to another color as mining progresses and escape routes change.



Highest Quality Construction and Advanced Safety Features



CAB Extra High Visibility Lifeline features the most brilliant reflective markers in the industry. Markers are firmly attached to Lifeline and can't break or fall off like other reflectors. Available in rope and heavy duty aircraft style. Lifeline Hangers are shown on page 13.

Hand Crafted to Rigid Quality Standards

CAB Lifeline is available in rope and heavy duty aircraft cable styles. Lifeline sections quickly and securely lock together with heavy duty aircraft cable oval sleeves, thimbles and quick links. CAB Rope Lifeline is manufactured from 1/4" (6.4mm) diameter, yellow, flame retardant polypropylene rope. Available in 300' (91.4m) and 1,000' (304.8m) spools.

CAB Tie-On Markers

CAB Tie-On Markers can be easily added to existing Lifeline. Made from 2" x 4" (51mm x 102mm) brilliant retroreflective vinyl. Stitched on all sides. Strong nylon cord is sewn into top hem for securely tying markers to Lifeline.



CAB Spiral Coil Rumble Strips

Used on branch lines that lead to refuge alternative. Strips measure 2" x 8" (51mm x 203mm) and are easily threaded into strands of existing Rope Lifeline or can be attached with cable ties to Aircraft Cable or Rope Lifeline.

High Quality Construction and Spooling for Quick and Easy Installation

CAB Lifeline requires no assembly and is ready to install. All parts are integral and securely attached with aircraft cable hardware. Lower in overall cost compared to other brands that require stocking of parts and extra labor for assembly.

See page 13 for Lifeline Hangers.

CAB Heavy Duty Aircraft Cable Lifeline (patent pending) is much more durable, especially in case of mine fires, explosions or rock falls. Made from strong 3/16" (5mm) diameter plastic coated, galvanized aircraft cable for maximum durability and safety. Sold in 300' (91.4m) spools.

CAB Split Cones



Identical to standard cones except featuring a pre-engineered hole and slit on one side for easy and secure attachment to previously installed Lifeline. Use two cones on main Lifeline to mark all branch lines. Use four cones, forming two diamond shapes on branch lines, to indicate SCSR storage caches. Sold in kits of 10 cones and 20 stop sleeves.

CAB Lifeline Balls



CAB Balls are used for marking location of mine personnel doors. Solid and durable, yet lightweight. Firm, secure attachment features a pre-engineered hole and slit on one side for quick, easy installation. Sold in kits of 10 balls and 20 stop sleeves.

CAB Cones and Balls are tough, durable and stay securely attached to Lifeline.



No Assembly Required!

CAB® High Visibility Reflective Tubes

Greatly Improves Visibility and Safety in Mines
Provides 360° Visibility in 11 Brilliant Reflective Colors

Available in Lengths
6 Inches to 6 Feet
(152mm to 1.8m)

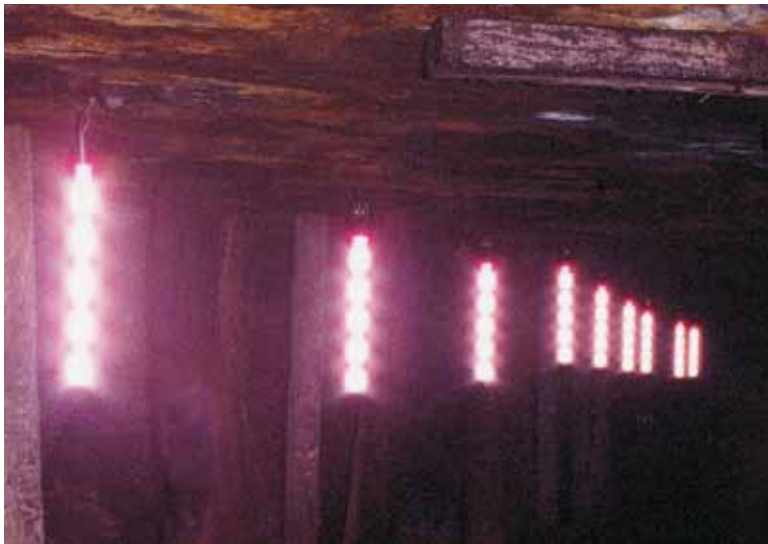

Tubes and Streamers are offered in these standard lengths:
6" (152mm)
12" (305mm)
18" (457mm)
24" (610mm)
30" (762mm)
36" (914mm)
48" (1.2m)
60" (1.5m)
72" (1.8m)
Custom sizes available.



CAB Solid Reflective Tube

CAB Striped Reflective Tube

CAB tubes are highly versatile in a mine color code identification system.

CAB Tubes greatly improve visibility and safety when marking low roof, hazard areas, unsupported roof, etc. Tubes can also be slid over rods for marking haulage roads and unload areas. Eleven different colors available on tubes. Colors may be used alone or in combination with another on individual tubes. Striped tubes have reflective bands alternating with sections of black non-reflective tubing. Solid tubes have reflective bands adjoining each other to provide a solid reflective surface.

Made from lightweight, durable 1-1/4" (32mm) diameter thin wall black tubing covered with microprism retroreflective vinyl. Has exceptional brilliance and true colors for marking and identification. Smooth reflective surface won't impregnate with dust and dirt like other reflective materials. Can be wiped clean to restore brilliance. Tubes may be hung vertically with 1 grommet or horizontally with no grommets or 2 grommets. Optional S-hooks available for faster installation. Packaged 50/box. Standard lengths listed above.

CAB® High Visibility Reflective Streamers



Heavy weight, double sided reflectors useful in a wide variety of underground applications. Manufactured from microprism retroreflective vinyl with brass grommet. Extremely brilliant with true color reflection. Available in 11 different colors for a complete mine color code identification system. Both sides can have the same color or 2 different colors. One side may also be non-reflective. Flexible and impact resistant with a smooth surface that can be wiped clean. Available with S-hook or special roof plate clip for quick installation, as shown on opposite page. Streamers are 1-3/8" (35mm) wide in standard lengths listed above. Also available with wording such as "MANDOOR", "CAUTION", "SHUT-OFF VALVE", etc. Packaged 50/box. Some minimums apply on custom orders.

CAB can handle custom wording!



CAB® High Visibility Clip-On Markers

Installs Quickly and Easily on Plates
Stays Oriented in Proper Direction at All Times



CAB Clip-On Markers are an industry favorite for identification of primary and secondary escapeways.



CAB Clip-On Markers

Exceptionally brilliant reflectors that quickly and easily attach to roof bolt plates with CAB's exclusive "tight grip" clip-on system. CAB's installation clips are made from heavy duty galvanized spring steel that firmly grips plate to securely hold reflector in proper position at all times. Quick and easy clip-on system saves time compared to installing reflectors with tie wire or cable ties.

Markers are made from high visibility retroreflective vinyl, exceptionally brilliant and impact resistant. Ideal marker for identification of primary and secondary escapeways. Custom wording available: "DOOR", "PUMP", etc. Markers 2" x 7" or 2" x 9" (51mm x 178mm or 51mm x 229mm). Available in 11 colors. Same or different colors on each side. Minimums may apply on custom orders.

CAB Clip-On Marker Standard Colors:

- CAB 468** red/green, 2" x 7" (51mm x 178mm), 50/box, 31 lb. (1.4kg)
 - CAB 7201** red/green, 2" x 9" (51mm x 229mm), 50/box, 31 lb. (1.4kg)
 - CAB 469** red/yellow, 2" x 7" (51mm x 178mm), 50/box, 31 lb. (1.4kg)
 - CAB 7202** red/yellow, 2" x 9" (51mm x 229mm), 50/box, 31 lb. (1.4kg)
 - CAB 470** red/red, 2" x 7" (51mm x 178mm), 50/box, 31 lb. (1.4kg)
 - CAB 7209** red/red, 2" x 9" (51mm x 229mm), 50/box, 31 lb. (1.4kg)
 - CAB 474** white/white, 2" x 7" (51mm x 178mm), 50/box, 31lb. (1.4kg)
- (Many other colors available.)**



CAB Clips can also be used on CAB Tubes and Streamers.

CAB Sidewall Markers

Manufactured from brilliant reflexite material for extra visibility. Full size galvanized metal bracket insert with 90° bend and hole for side wall mounting. Markers are 2" x 7" (51mm x 178mm) and reflective on one or both sides. Heavy black webbing on all non-reflective sides. Available with custom wording.



CAB® Color Chart for Tubes, Streamers and Markers

- ✓ Provides complete mine color code identification system.
- ✓ Improves safety by identifying hazards, escapeways, doors, etc.
- ✓ Tubes, streamers, markers made in single or multiple colors.
- ✓ True colors are reflected for improved identification and safety.
- ✓ Microprism retroreflective vinyl is durable, impact resistant and exceptionally brilliant.
- ✓ Won't impregnate with dust and dirt like other reflective material.
- ✓ Reflects at wider angles and greater distances for better visibility.



White



Fluorescent Pink



Fluorescent Orange



Orange



Fluorescent Green



Fluorescent Red Orange



Fluorescent Lime Yellow



Red



Green



Blue



Yellow



CAB® High Visibility Rock Dust Bags

Provides strong, dry, high visibility storage for rock dust used for fire protection in mines. Made from nylon reinforced vinyl, which is tear resistant, durable and waterproof. Bright red-orange material resists mold, mildew, rotting and most chemicals. High visibility red-orange reflective bands for added safety. High quality features include folded and sewn seams to resist moisture and velcro tabs on front flap for fast access to rock dust. Large capacity bags have 2 heavy duty webbing handles for 1 or 2 man carry of rock dust.

CAB 794 17" x 23" (432mm x 584mm) bag, non-reflective, 25/box, 16 lb. (7.3kg)

CAB 795 17" x 23" (432mm x 584mm) bag w/ 1 reflective band, 25/box, 17 lb. (7.7kg)

CAB 796 17" x 23" (432mm x 584mm) bag w/ 2 reflective bands, 25/box, 17 lb. (7.7kg)

CAB 797 21" x 26" (533mm x 660mm) large bag w/ 1 reflective band, 2 handles, 25/box, 26 lb. (11.8kg)



CAB High Visibility Fire Extinguisher Bags

Clean, dry, high visibility storage for fire extinguishers used in mines. Bags help ensure extinguishers will be ready to operate in emergencies. Also helps keep inspection tags from being vandalized, lost or damaged. Made from strong laminated nylon with clear top dome for checking gauges and tags. High visibility reflective band around entire bag provides faster identification of extinguisher.

Bag can be hung anywhere with heavy duty webbing top loop. For added strength, webbing encircles entire bag. Sturdy webbing side handles make fire extinguisher easier to carry. Quick access is provided when handles are pulled apart to open velcro seal which runs along the entire right side of bag. High quality construction and materials. Slip-over and custom bags available for extinguishers up to 150 pounds (68.2kg).

CAB 805 10 lb. (4.5kg) extinguisher, 8" (203mm) dia., 21-1/2" (546mm) height, 18" (457mm) opening, 25/box, 17 lb. (7.7kg)

CAB 806 10 lb. (4.5kg) long extinguisher, 8" (203mm) dia., 25" (635mm) height, 23" (584mm) opening, 25/box, 18 lb. (8.2kg)

CAB 807 20 lb. (9.1kg) extinguisher, 9" (229mm) dia., 25" (635mm) height, 22-1/2" (572mm) opening, 25/box, 21 lb. (9.5kg)

CAB 808 20 lb. (9.1kg) long extinguisher, 9" (229mm) dia., 32" (813mm) height, 29" (737mm) opening, 25/box, 23 lb. (10.5kg)



CAB High Visibility Custom Bags

Made for the safe, secure storage of batteries, detectors, meters, tools and other equipment. Made from a variety of heavy duty materials such as 1000 denier fluorescent orange cordura. Can be designed to carry on belt, shoulder, back or vehicle. For added safety, high visibility reflective bands in eleven colors can be sewn on any surface.

CAB Longwall Gaitors

High quality covers designed to protect longwall cylinders from constant exposure to dust, dirt and water.

Made from heavy duty material with a strong velcro, zipper or snap closure along one side. CAB Gaitors are more cost effective than factory gaitors and are custom made in a wide variety of styles. Also available with reflective bands for improved safety.

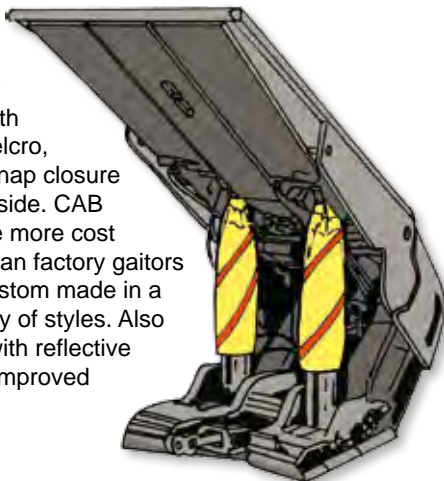

CAB Reflective Pipe and Cable Covers



Provides brilliant reflective surface for identification and marking of pipe and cable. Covers are flexible, impact resistant and have a strong velcro closure for quick and easy installation. The 25' (7.6m) covers can be installed on cable reels to alert machine operators that end of cable has been reached in shuttle cars, miners and roof bolters. All covers ordered by circumference of pipe or cable. Available in a variety of sizes up to 25' (7.6m) long. Some minimums apply.

CAB 515 Fits cable 3-3/4" to 4-1/2" (95-114mm) circumference, lime yellow, 25' (7.6m) long.

CAB 513 Fits cable 5-1/8" to 6" (130-152mm) circumference, lime yellow, 25' (7.6m) long.

CAB 516 Fits cable 3-3/4" to 4-1/2" (95-114mm) circumference, red orange, 25' (7.6m) long.

CAB 514 Fits cable 5-1/8" to 6" (130-152mm) circumference, red orange, 25' (7.6m) long.

CAB® Rescue Tag Line

Helps a Mine Crew Stay Together and Evacuate Safely During an Emergency Escape

CAB Rescue Tag Lines are manufactured from heavy duty 7/16" (11mm) diameter, bright yellow, hollow-braid polypropylene rope. Each man is attached to the end of a 3' (914mm) tether that is securely spliced to the main line at 5' (1.5m) intervals. Large capacity, corrosion resistant #2 bronze swivel snaps are used to hook each miner to tether. Swivel snaps are spliced to end of tethers and both ends of main line. Manufactured with extra heavy duty splices and no hardware other than swivel snaps to reduce possibility of tangling in an emergency.

Tag Line is coiled carefully on sturdy plastic carrier with handle that allows line to be put into action quickly and easily. Can be used individually to evacuate a single crew or linked together to evacuate multiple crews. Lines packaged in single or double bags made from fluorescent lime-yellow nylon with red-orange reflective bands and carry strap. Tag Lines available in custom styles and small sizes for storage boxes on personnel carriers.

CAB Double Bag Rescue Tag Lines can be used individually or linked together for multiple crews.

CAB Rescue Tag Lines are carefully coiled on a sturdy plastic carrier with handle to deploy quickly without tangling. CAB Rescue Tag Lines feature strong bronze swivel snaps and extra heavy-duty splices. All bags are clearly marked with high visibility reflective bands and crew size of unit.

CAB Belt Pouch Rescue Tag Line

Connects One Miner to Another for Emergency Escape

CAB Rescue Tag Line:

- CAB #7404 1-2 man Tag Line, 1 main line, 1/bag
- CAB #7405 1-2 man Tag Line, 1 main line, 2/bag
- CAB #7348 2-4 man Tag Line, 2 tethers, 1/bag
- CAB #7349 2-4 man Tag Line, 2 tethers, 2/bag
- CAB #7351 4-6 man Tag Line, 4 tethers, 1/bag
- CAB #7352 4-6 man Tag Line, 4 tethers, 2/bag
- CAB #7105 6-8 man Tag Line, 6 tethers, 1/bag
- CAB #7353 6-8 man Tag Line, 6 tethers, 2/bag
- CAB #7191 8-10 man Tag Line, 8 tethers, 1/bag
- CAB #7192 8-10 man Tag Line, 8 tethers, 2/bag
- CAB #7430 10-12 man Tag Line, 10 tethers, 1/bag
- CAB #7431 10-12 man Tag Line, 10 tethers, 2/bag
- CAB #7104 13-15 man Tag Line, 13 tethers, 1/bag

CAB Belt Pouch Rescue Tag Line:

- CAB #7542 1-2 man CAB Belt Pouch Tag Line, tether attached to pouch with 1 snap, 10/box
- CAB #7543 1-2 man CAB Belt Pouch Tag Line, tether removable with 2 snaps, 10/box

CAB's Belt Pouch Rescue Tag Line is worn on miner's belt to connect one miner to another if an emergency escape is necessary. Pouch is made from 1000 denier blaze orange cordura. Folding top flap with velcro closure provides quick access. Webbing tether has one end sewn securely to inside of pouch. Tether is 1" (25mm) wide by 5' (1.5m) long with sturdy bronze swivel snap on end. Also available with removable tether with bronze swivel snaps on both ends. According to current federal regulations, CAB Rescue Tag Lines for a crew as outlined at top of page, are the type required on all vehicles that enter and exit mine. CAB Belt Pouch Rescue Tag Lines can supplement these more advanced Tag Lines and provide extra measure of safety.

CAB® High Visibility Safety Belt Harnesses



CAB High Contrast Safety Belt Harnesses

Very effective for improving the visibility of above or below ground employees. Provides excellent 360° visibility. Lightweight, comfortable and easy to work in. Made from 2-1/2" (64mm) wide heavy duty fluorescent orange laminated nylon. Brilliant fluorescent lime-yellow reflective bands are 1-3/8" (35mm) wide on shoulders and 2" (51mm) wide around waist. For added safety and adjustment, harnesses have velcro closures on shoulders, chest and waist.

- CAB 6994** regular
- CAB 6989** large/x-large
- CAB 6990** 2x-large/3x-large
- CAB 6991** 4x-large/sumo



CAB Heavy Duty Safety Belt Harnesses

Greatly improves visibility of miners, contractors or visitors. Made from sturdy webbing with 1-3/8" (35mm) wide brilliant reflective bands over the entire surface. Available in 11 different colors. Velcro closures on shoulders, chest and waist make belts fully adjustable for added safety. Also available with velcro at top of shoulders for a 6 point release. Lightweight, comfortable and easy to work in. Standard color fluorescent green. Minimums apply for other colors.

- CAB 1591** medium, fl. green, 38"- 44" (965mm x 1.1m) circumference
- CAB 1598** large, fl. green, 42"- 48" (1.1m x 1.2m) circumference
- CAB 1606** x-large, fl. green, 48"- 54" (1.2m x 1.4m) circumference
- CAB 1613** 2x-large, fl. green, 54"- 60" (1.4m x 1.5m) circumference



CAB High Visibility Cap Lamp Cord Covers

Bright, reflective covers designed to fit over standard cap lamp cords. Durable and flexible to protect cords from abrasion damage. Cords are threaded through covers for a tight, secure installation. For faster installation, specify model with velcro closure along entire length.

- CAB 860** 30" (762mm) long, white, 50/box, 4 lb. (1.8kg)
- CAB 862** 30" (762mm) long, with velcro closure, white, 50/box, 5 lb. (2.3kg)



CAB High Visibility Suspenders

Manufactured from 2" (51mm) wide fluorescent lime yellow elastic with 4 sturdy buckles. A 3/4" (19mm) wide silver glass bead reflective strip runs entire length of the suspenders. Two durable slide buckles allow for easy adjustment to any size.

- CAB 2986** 25/box, 10 lbs. (4.5kg)



CAB Reflective Stickers

Designed to provide extra visibility to hard hats. Adhesive stickers made from brilliant reflexite material. 1" x 4" (25mm x 102mm) in fluorescent lime yellow and fluorescent orange. 16 peel-off stickers per sheet.

- CAB 6350** fl. lime-yellow, 25 sheets/box, 4 lb. (1.8kg)
- CAB 6976** fl. orange, 25 sheets/box, 4 lb. (1.8kg)

CAB® High Visibility Safety Vests



Ask us about front pockets and wording on the back of these vests!



CAB Yellow Green Mesh Safety Vests

High quality vests that meet and exceed ANSI/ISEA specifications for Class II high visibility safety apparel. Made from 3.4 oz. soft fluorescent polyester mesh for good flexibility and ventilation. Vest has 2" (51mm) wide silver reflective tape with 1/2" (13mm) wide red/orange edging on shoulders, chest and waist. Open front velcro closure and reflective velcro side closure for adjustment and 360° visibility. Available with 2 full panel width pockets 7" (178mm) deep with velcro closures.

Without Pockets:

- CAB 7395 regular
- CAB 7396 large
- CAB 7397 x-large
- CAB 7398 sumo

With Pockets:

- CAB 7399 regular
- CAB 7400 large
- CAB 7401 x-large
- CAB 7402 sumo

CAB Orange Mesh Safety Vests

High quality, heavy duty vests greatly improve employee visibility and safety. Made from blaze orange soft polyester mesh for good flexibility and ventilation. Front and back have 3 bands of fluorescent lime-yellow retroreflective tape. Open front velcro closure and velcro side adjustments. Extra Reflective Vest has 3" (76mm) wide reflective bands and side closures. Pockets and custom wording available.

Standard Style:

- CAB 1544 regular
- CAB 1557 large
- CAB 1779 x-large
- CAB 1538 sumo

Extra Reflective Style:

- CAB 1553 regular
- CAB 1566 large
- CAB 1782 x-large
- CAB 5812 sumo



CAB Self Rescuer Bags

Extra protection for self rescuers during transport and storage. Constructed with 2 layers of heavy duty 1000 denier cordura and 1/2" (13mm) thick foam core for extra padding and protection. The brilliant reflexite tape and fluorescent orange cordura greatly improves visibility. Windows allow for reading of gauges. Entire lid sealed with velcro. Sturdy 1-1/2" (38mm) wide webbing straps with buckles for adjustment in both shoulder strap and back pack models. Variety of styles available.



CAB Self Rescuer Belt Holders

Designed to firmly and safely hold self rescuers on a miner's belt. Made from heavy duty polypropylene webbing and brilliant reflexite material for improved visibility and safety. Available in a variety of styles.



CAB Reflective Arm and Leg Bands

Manufactured from 2" (51mm) wide fluorescent lime-yellow elastic with velcro on each end for attachment. A 3/4" (19mm) wide silver glass bead reflective strip runs entire length of band. Available in 2 lengths.

- CAB 4012 12" (305mm) long, 50/box
- CAB 4013 15" (381mm) long, 50/box

Highest Quality Products to Improve Mine Safety and Productivity

CAB®

Used in the Most Demanding Above and Below Ground Applications Around the World



Throughout the mining industry, CAB Products are widely recognized for their high quality and excellent design. CAB Hangers greatly improve safety and help cut operating costs by supporting and organizing pipe, tubing and all types of cables.

For added safety and protection, all hangers are insulated with a heavy coating of high dielectric grade, flame retardant plastisol in the carrier section of the hanger. The bright orange color provides an extra measure of safety and has been a trademark of CAB quality over the years.

CAB also manufactures a wide variety of high visibility reflective products that greatly improve marking, identification and safety in mines. To provide a complete mine color code identification system, CAB offers a line of high visibility reflective tubes, streamers and markers in eleven brilliant retroreflective colors.

Other innovative CAB products that improve mine safety include rescue tag lines, cable pullers, rock dust bags and cable covers. To improve the visibility and safety of miners, CAB manufactures a line of high visibility reflective safety vests, safety belt harnesses, suspenders and self-rescuer bags.

Cambria County Association for the Blind and Handicapped

175 Industrial Park Road

Ebensburg, PA 15931-4109 USA

Phone: (814) 472-5077

Fax: (814) 472-7179

E-mail: cab@cabproducts.co.za

Web: www.cabproducts.co.za

CAB Hangers are designed to meet all requirements for the support of cables in underground mines as set forth in the code of federal mine regulations 30 CFR Part 75. The standard line of Mine Hangers also meets the stringent standards necessary to receive full CSA Certification.



CAB has a long tradition of working with mining companies to manufacture high quality products that improve mine safety. Partnering with a mine in 1985, CAB was the first company to produce a Lifeline for emergency escape from underground mines. CAB has steadily improved the safety features on the Lifeline and added new designs such as the first Aircraft Cable Lifeline and the first High Visibility Lifeline with integral reflective markers. Today, the CAB Lifeline remains the industry favorite and is used in both coal and hard rock mines around the world.

The Cambria County Association for the Blind and Handicapped is dedicated to providing job opportunities and services to persons with disabilities through the CAB Product line.

All of the items in the CAB Product line are manufactured by CAB employees with great pride and integrity. CAB deeply appreciates the help and support of our customers over the years. Through your orders, many disabled persons have been given the opportunity to be productive and independent by manufacturing CAB Products.

Thank you very much for using CAB Products.

CM **CABLE**
MANAGEMENT
cable support solutions



CABLE MANAGEMENT PTY LTD

Unit K12, Okavango Junction

Kenwil Drive

Brackenfell 7560

Cape Town

SOUTH AFRICA

www.cablemanagement.co.za

Tel: +27 72 195 9058

email: sales@cablemanagement.co.za